

50Hz



GENERAL CATALOGUE

www.pentax-pumps.it



HISTORY

For many years **Pentax** has held a large share of the world market for motorized pumps. The sales department is constantly working to better serve existing customers and to open up new markets. This is possible thanks to the wide range of products available which allows to cover most of the applications in the pump field. Special attention is also paid to market surveys, so that any new requirements can be immediately transferred to the research and development department: the best way to properly develop and forecast future scenarios.

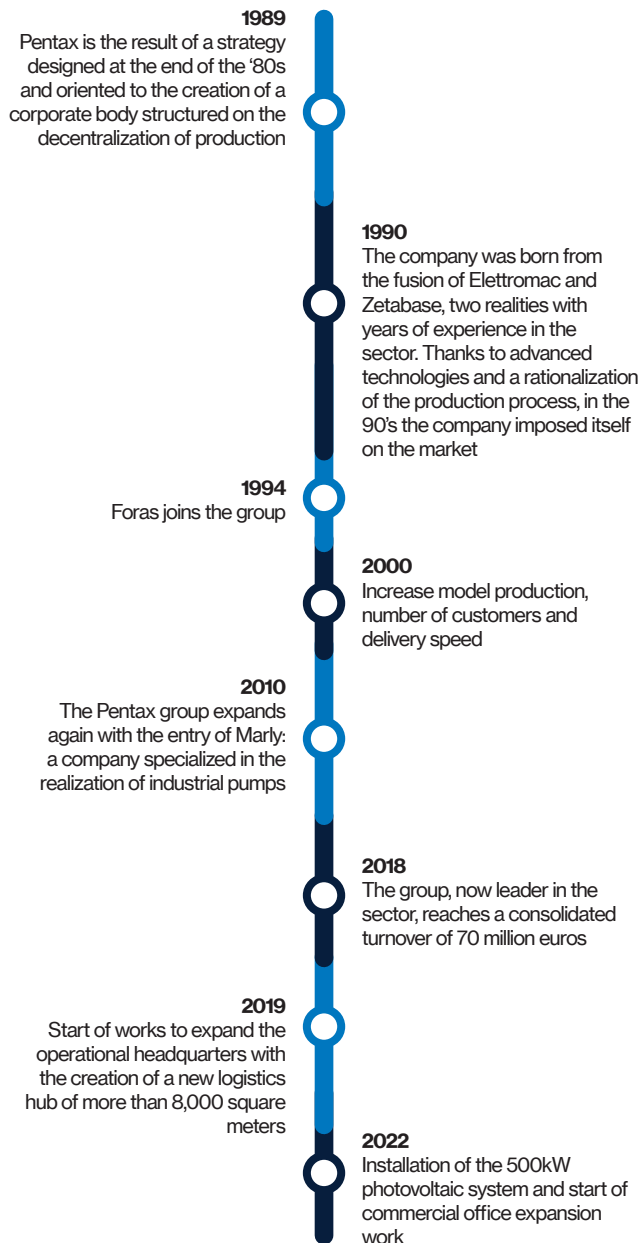

MISSION

After more than **20 years of activity** we can finally trace the guidelines that have governed and directed the industrial development of **Pentax Industries SpA**. Actions and processes that have intersected with the obvious aim of creating value, benefits to be redistributed to the various components of the production and distribution process.

A rational allocation of available resources, together with a refined program of production decentralization have allowed the company to adapt to changing market conditions, each time with extreme rapidity.

Maximum attention to the markets, therefore, with the commitment to respond in real time to the specific needs of the different markets, paying particular attention to technological progress. All this in the perspective of a careful policy for **customer satisfaction**.

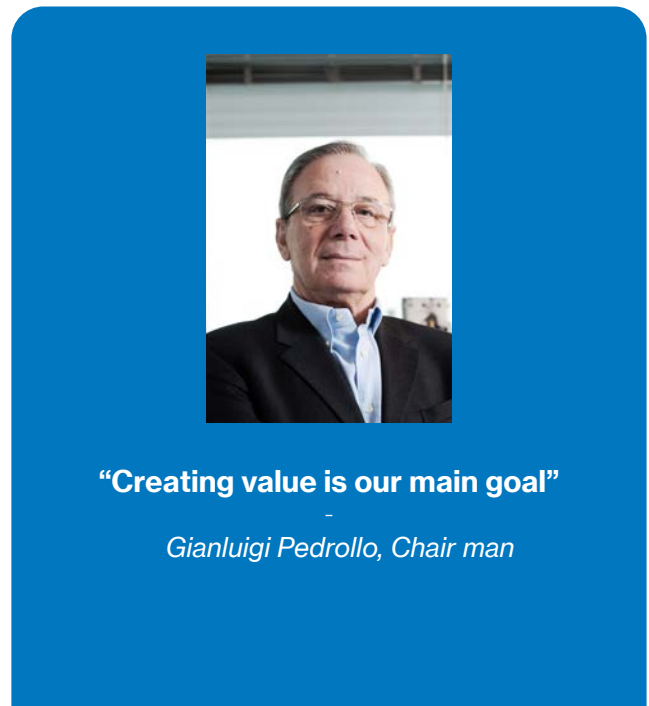

“Creating value is our main goal”

Gianluigi Pedrollo, Chair man

VALUES



Reliability

Choosing Pentax means choosing safety at every stage

Quality

Where there is control, there is reliability: the basis for success

Speed

Impeccable delivery time

Flexibility

Pentax studies each case thoroughly, identifies the best solution and then takes action with security

Variety

The best service: a wide range of Pentax products, one for every need



OFFICIAL JOURNAL OF THE EUROPEAN UNION

Regulation UE 547/2012

ANNEX II

«The benchmark for most efficient water pumps is $MEI \geq 0,70$ ».

«The efficiency of a pump with a trimmed impeller is usually lower than that of a pump with the full impeller diameter. The trimming of the impeller will adapt the pump to a fixed duty point, leading to reduced energy consumption. The minimum efficiency index (MEI) is based on the full impeller diameter».

«The operation of this water pump with variable duty points may be more efficient and economic when controlled, for example, by the use of a variable speed drive that matches the pump duty to the system».

Information on benchmark efficiency is available at:

www.europump.org/efficiencycharts.



ULTRA SA

Self-priming



Self-priming horizontal multistage stainless steel pumps suitable for domestic use, also in combination with autoclave tank. Suitable for drinking water or glycol, for water treatment, heating, air conditioning and washing systems.

Construction features

Pump body, mechanical seal housing	stainless steel AISI 304
Motor bracket	aluminum
Impellers, diffusers	stainless steel AISI 304
Mechanical seal	ceramic-graphite-EPDM
Motor shaft	stainless steel AISI 303
Liquid temperature	-15 ÷ +110 °C
Operating pressure	max 7 bar

Motor

	3~ 230/400V - 50Hz
2 poles induction motor	1~ 230V - 50Hz (with thermal protection up to 1.85 kW)
Insulation class	F
Protection degree	IPX4

U 3 S A - 100 / 5 T

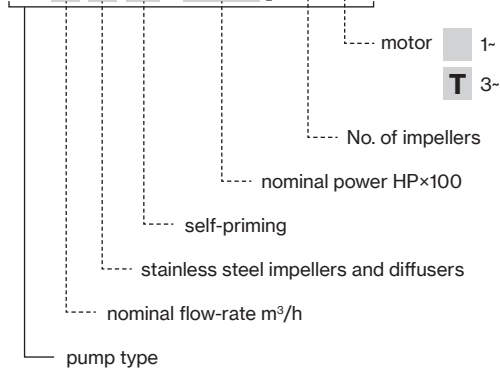

TYPE	TRUCK		CONTAINER	
	PALLET (cm)	N° pumps	PALLET (cm)	N° pumps
U 3SA-90/4	85×110×160	70	85×110×185	80
U 3SA-100/5	80×120×150	42	80×120×175	49
U 5SA-120/4	80×120×150	42	80×120×175	49
U 5SA-150/5	80×120×150	42	80×120×175	49



ULTRA SA

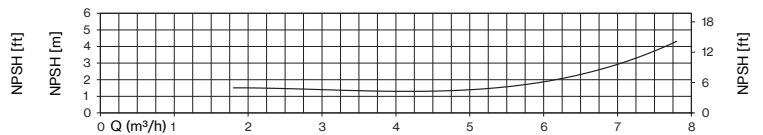
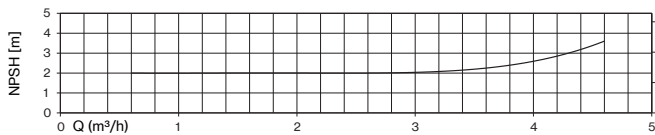
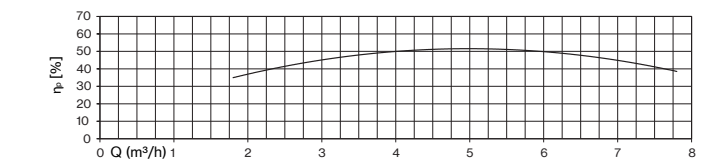
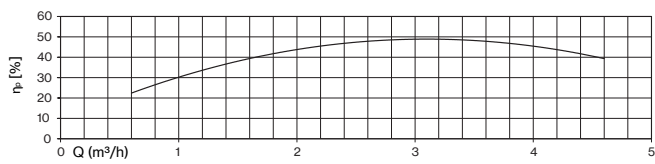
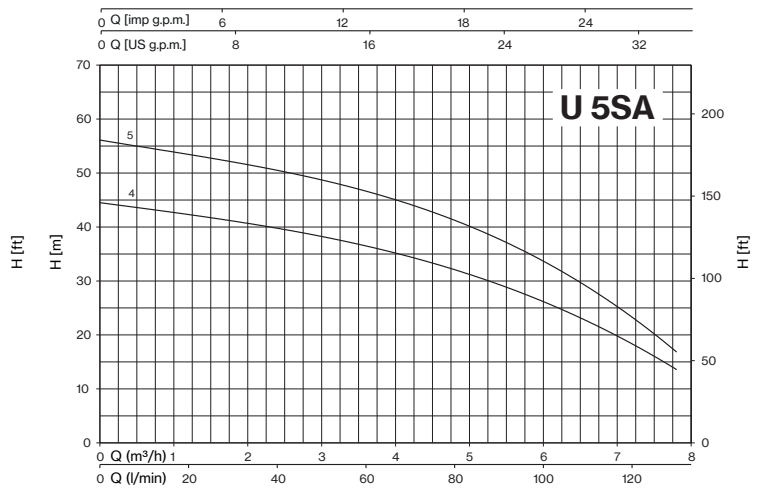
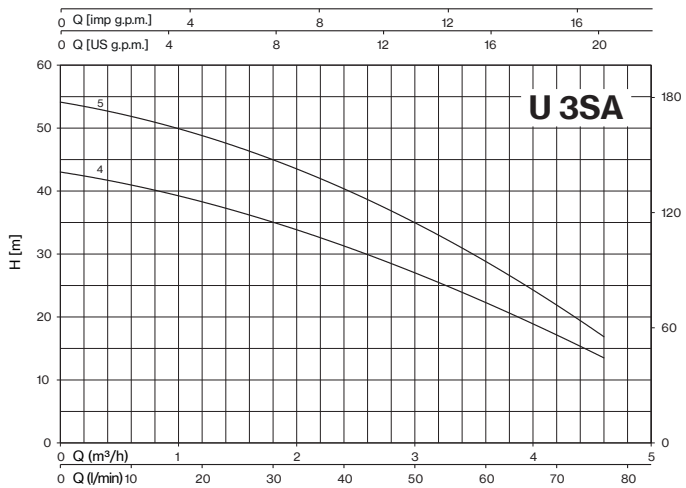

TYPE		P2		P1 (kW)		AMPERE		Q (m³/h - l/min)											
1~	3~	HP	kW	1~	3~	1~ 230V 50 Hz	3~ 400V 50 Hz	0	0,6	1,2	1,8	2,4	3,6	4,6	4,8	6	7	7,8	
								0	10	20	30	40	60	76,7	80	100	116,7	130	
								H (m)											
U 3SA-90/4	U 3SA-90/4T	0,9	0,66	0,83	0,8	3,6	1,7	43,0	41,0	38,3	35,0	31,3	22,3	13,5					
U 3SA-100/5	U 3SA-100/5T	1	0,75	0,99	0,92	4,4	1,7	54,0	52,1	48,8	44,9	40,2	29,0	16,8					
U 5SA-120/4	U 5SA-120/4T	1,2	0,9	1,09	1,08	4,9	2,4	44,5			41,0	40,0	36,4	32,8	32,0	26,2	18,5	13,5	
U 5SA-150/5	U 5SA-150/5T	1,5	1,1	1,39	1,31	6,5	2,7	56,0			52,4	50,5	46,4	42,0	41,0	33,8	23,8	16,5	

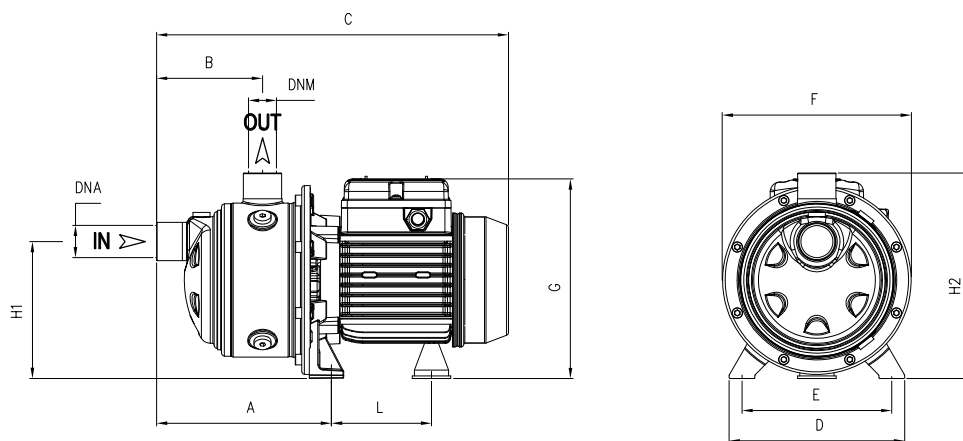

TYPE	DIMENSIONS (mm)												Kg
	A	B	C	D	E	F	G	L	H1	H2	DNA	DNM	
U 3SA-90/4	238,8	175	405	164	140	178	190	93,7	128	192	1" G	1" G	10
U 3SA-100/5	262,8	199	452	164	140	178	203	104,7	128	192			12,5
U 5SA-120/4	238,8	175	428	164	140	178	203	104,7	128	192			12,5
U 5SA-150/5	262,8	199	514	164	140	201	211	128,2	134	198			15,5

