

**50Hz**



# **GENERAL CATALOGUE**

**Edition 2022**

[www.pentax-pumps.it](http://www.pentax-pumps.it)

# Where there's water there's Pentax



Viale dell'Industria, 1  
37040 Veronella (VR) - Italia  
Tel. +39 0442 489500  
Fax +39 0442 489510  
com@pentax-pumps.it  
[www.pentax-pumps.it](http://www.pentax-pumps.it)

**PENTAX s.p.a.**



# ULTRA

## Multistage Horizontal

Stainless steel multistage horizontal pumps. Pumping of clean non-loaded fluids, pressurizing system, irrigation, drinking and glycol water, water treatment, heating and air conditioning, washing system.

### Construction features

<b>Pump body, mechanical seal housing</b>	stainless steel AISI 304
<b>Motor bracket</b>	aluminium
<b>Impeller, diffusers</b>	Noryl®
<b>Mechanical seal</b>	ceramic-graphite ≤ 6 impellers graphite-silicon carbide ≥ 7 impellers
<b>Motor shaft</b>	stainless steel AISI 303
<b>Liquid temperature</b>	-5 ÷ +35 °C
<b>Operating pressure</b>	max 8,5 bar

### Motor

	3~ 230/400V-50Hz
<b>2 poles induction motor</b>	1~ 230V-50Hz (with thermal protection up to 1,85 kW)
<b>Insulation class</b>	F
<b>Protection degree</b>	IPX4



**U 3 - 120/6 T**

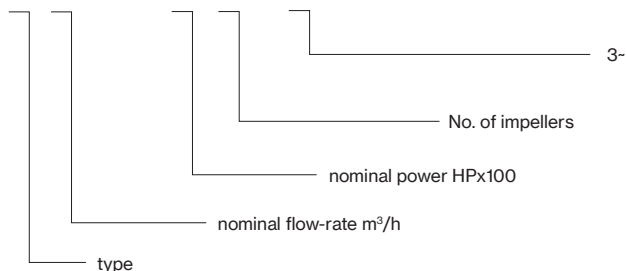

ULTRA 3



ULTRA 5



ULTRA 7



ULTRA 9



ULTRA 18



TYPE		P2		P1 (kW)		AMPERE		Q (m³/h - l/min)							
1-	3-					1-	3-	0	0,6	1,2	1,8	2,4	3,6	4,8	
								0	10	20	30	40	60	80	
		HP	kW	1-	3-	1x230 V 50 Hz	3x400 V 50 Hz	H (m)							
U 3-50/2	U 3-50/2 T	0,5	0,37	0,45	0,46	2	0,9	20,2	18,8	17,3	15,3	13,7	9,5	4,9	
U 3-70/3	U 3-70/3 T	0,7	0,51	0,65	0,63	2,9	1,2	30,0	27,9	25,4	23,0	20,3	14,0	6,7	
U 3-90/4	U 3-90/4 T	0,9	0,66	0,9	0,88	4	1,8	40,8	38,3	35,1	31	27,9	19,8	10,4	
U 3-100/5	U 3-100/5 T	1	0,75	1,06	1,01	4,8	1,9	52,2	48,9	45,1	40,8	36,0	25,4	14,0	
U 3-120/6	U 3-120/6 T	1,2	0,9	1,23	1,23	5,6	2,6	62,8	58,7	54,5	49,6	43,9	32,1	18,3	
U 3-150/7	U 3-150/7 T	1,5	1,1	1,54	1,45	7,1	2,9	75,5	71,3	66,6	61,2	54,8	41,1	24,9	

TYPE		P2		P1 (kW)		AMPERE		Q (m³/h - l/min)							
1-	3-					1-	3-	0	1,8						
								0	30	40	60	80	100	120	140
		HP	kW	1-	3-	1x230 V 50 Hz	3x400 V 50 Hz	H (m)							
U 5-70/2	U 5-70/2 T	0,7	0,51	0,61	0,58	2,7	1,1	22,0	19,7	18,7	16,6	14,0	10,8	6,8	1,8
U 5-80/3	U 5-80/3 T	0,8	0,6	0,86	0,79	3,9	1,5	33,4	30,3	29,0	26,0	22,5	17,6	12,0	3,9
U 5-120/4	U 5-120/4 T	1,2	0,9	1,13	1,13	5,2	2,5	45,3	41,3	39,6	35,6	30,8	24,9	17,6	6,4
U 5-150/5	U 5-150/5 T	1,5	1,1	1,47	1,39	6,8	2,8	56,8	53,0	51,0	46,1	40,1	33,3	24,8	11,5
U 5-180/6	U 5-180/6 T	1,8	1,3	1,7	1,62	7,7	3	69,3	64,4	62,0	55,6	48,2	39,6	28,8	12,0
U 5-200/7	U 5-200/7 T	2	1,5	2	1,86	9	3,4	80,3	73,6	71,0	64,5	56,1	46,0	33,4	12,5

TYPE		P2		P1 (kW)		AMPERE		Q (m³/h - l/min)									
1-	3-					1-	3-	0	2,4	3,6	4,8	6	7,2	8,4	9,6	1	
								0	40	60	80	100	120	140	160	17	
		HP	kW	1-	3-	1x230 V 50 Hz	3x400 V 50 Hz	H (m)									
U 7-100/2	U 7-100/2 T	1	0,75	0,97	0,9	4,4	1,7	24,8	23,4	22,0	20,5	18,7	16,3	13,6	10,2	8,3	
U 7-120/3	U 7-120/3 T	1,2	0,9	1,32	1,3	5,9	2,6	36,7	34,0	32,0	29,6	26,5	23,0	18,6	13,8	11,0	
U 7-180/4	U 7-180/4 T	1,8	1,3	1,83	1,71	8,3	3,2	49,5	47,4	45,3	42,5	39,2	34,8	29,4	22,6	16,9	
U 7-250/5	U 7-250/5 T	2,5	1,85	2,39	2,15	10,9	4,2	62,6	60,6	58,2	55,1	51,1	45,8	39,0	29,8	21,5	
U 7-300/6	U 7-300/6 T	3	2,	2,68	2,63	12,2	5	74,8	71,5	68,3	64,5	59,3	53,0	44,6	34,5	26,7	
-	U 7-350/7 T	3,5	2,57		3,04		5,5	87,2	83,3	79,3	74,6	68,9	61,9	52,5	41,0	32,2	

TYPE		P2		P1 (kW)		AMPERE		Q (m³/h - l/min)													
1-	3-					1-	3-	0	3,6	4,8	6	7,2	8,4	9,6	10,8	12	13,2	14,4			
								0	60	80	100	120	140	160	180	200	220	240			
		HP	kW	1-	3-	1x230 V 50 Hz	3x400 V 50 Hz	H (m)													
U 9-100/2	U 9-100/2 T	1	0,75	0,98	0,92	4,4	1,7	23,0	20,9	20,0	19,1	17,9	16,6	15,0	13,2	11,1	8,9	6,5			
U 9-150/3	U 9-150/3 T	1,5	1,1	1,43	1,38	6,7	2,8	35,2	32,6	31,5	30,3	28,8	26,9	24,5	21,5	18,3	14,7	10,8			
U 9-200/4	U 9-200/4 T	2	1,5	1,88	1,77	8,4	3,3	47,1	43,5	42,0	40,5	38,3	35,7	32,4	28,4	23,8	18,9	13,3			
U 9-250/5	U 9-250/5 T	2,5	1,85	2,32	2,18	10,6	4,3	59,2	54,4	52,4	50,4	47,9	44,8	40,5	35,5	29,8	23,5	16,3			

TYPE		P2		P1 (kW)	A	Q (m³/h - l/min)																	
3-	3-					0	6	7,2	8,4	9,6	10,8	12	13,2	14,4	15,6	16,8	18	19,2	20,4	21,6	22,8	24	25,
						0	100	120	140	160	180	200	220	240	260	280	300	320	340	360	380	400	420
		HP	kW	3-	3x400 V 50 Hz	H (m)																	
U 18-180/2 T	1,8	1,3	1,52	3	23,1	21,4	21,0	20,5	19,9	19,2	18,4	17,6	16,7	15,7	14,7	13,5	12,1	10,9	9,7	8,3	7,0	5,5	
U 18-250/3 T	2,5	1,85	2,19	4,3	35,0	32,7	32,2	31,4	30,5	29,5	28,3	26,7	25,5	24,3	22,8	21,2	19,3	17,3	15,1	12,9	10,8	8,7	
U 18-400/4 T	4	3	2,99	5,5	47,2	44,6	44,1	43,3	42,4	41,2	40,0	38,5	36,7	34,9	32,9	30,5	27,9	25,3	22,7	20,0	17,1	14,3	



# ULTRA

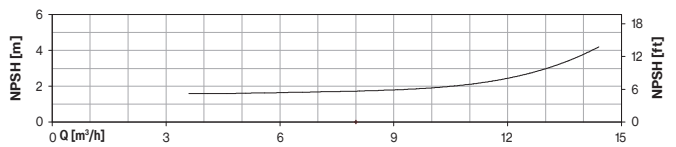
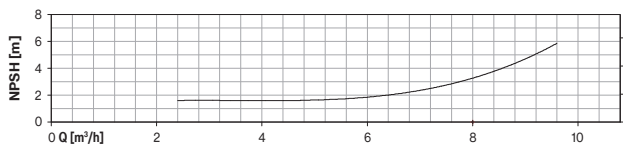
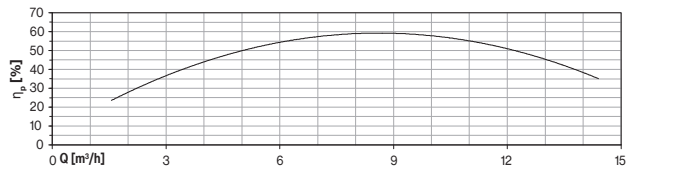
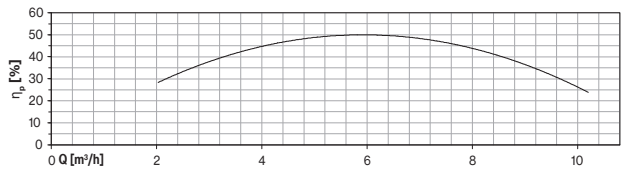
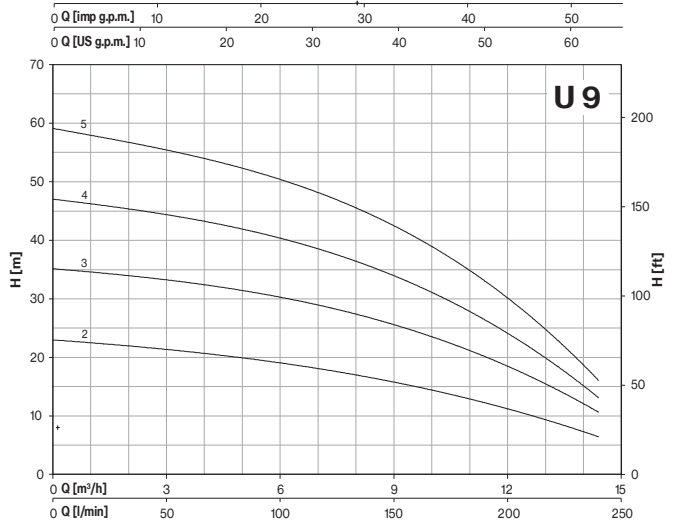
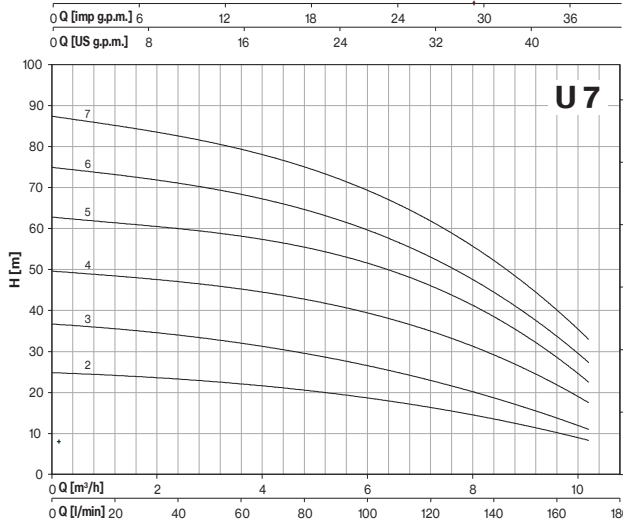
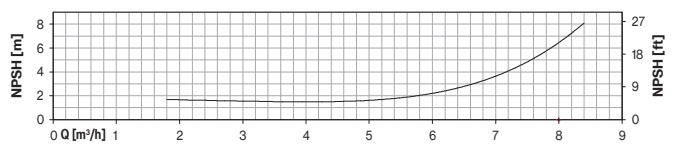
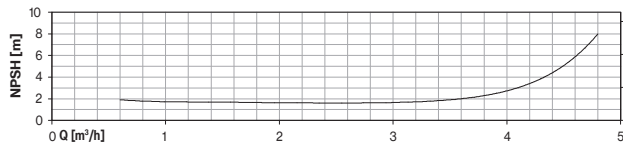
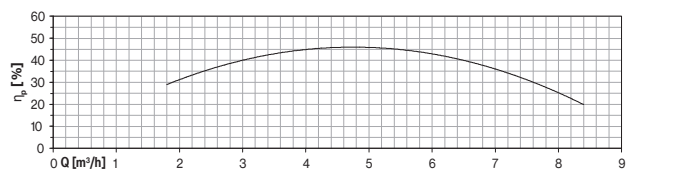
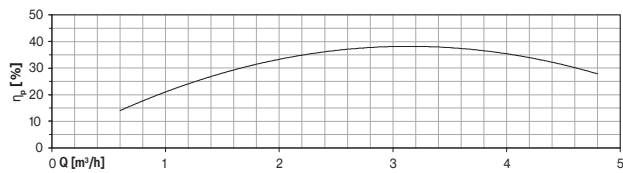
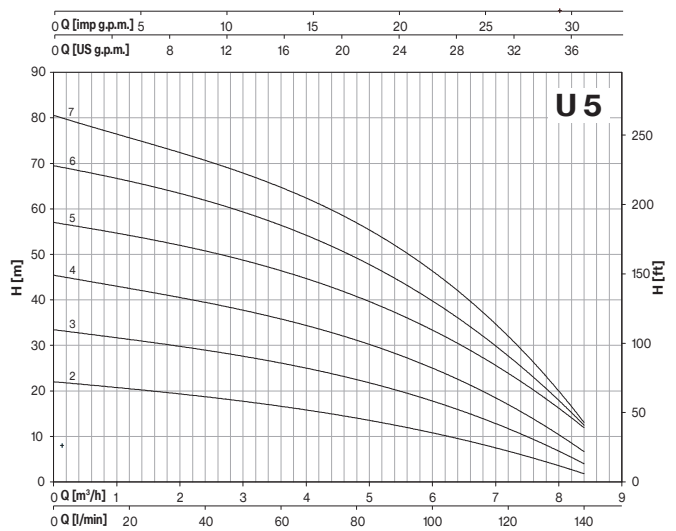
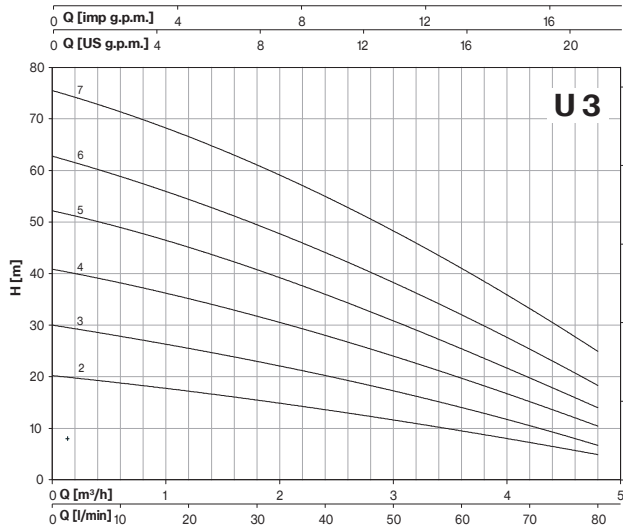

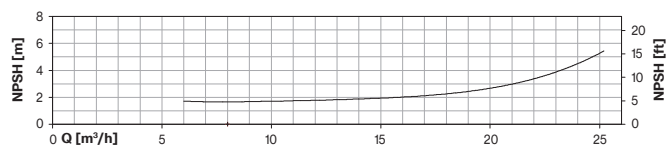
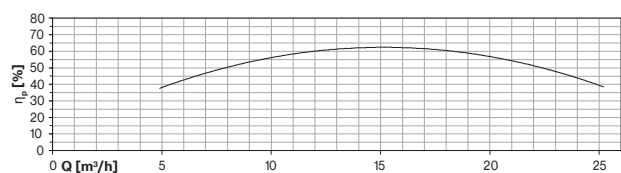
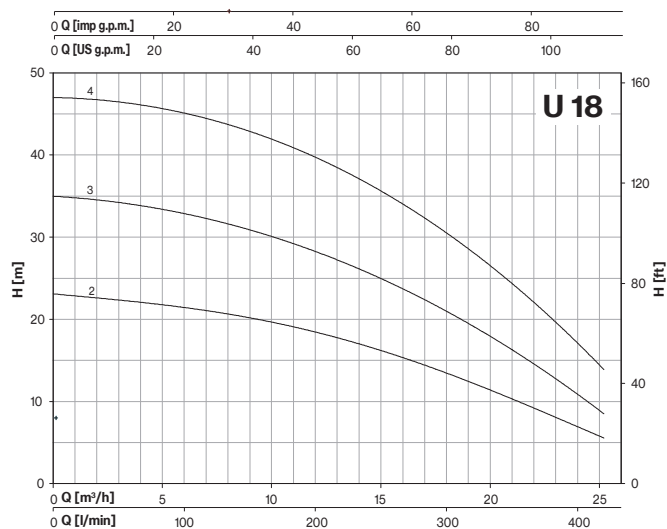

TYPE	LOTS			
	TRUCK		CONTAINER	
	PALLET (cm)	N° pumps	PALLET (cm)	N° pumps
U 3-50/2-90/4	80×120×150	84	80×120×175	96
U 3-100/5-120/6	85×110×160	70	85×110×185	80
U 3-150/7	80×120×150	42	80×120×175	49
U 5-70/2	80×120×150	84	80×120×175	96
U 5-80/3-120/4	85×110×160	70	85×110×185	80
U 5-150/5	90×110×150	54	90×110×170	63
U 5-180/6-200/7	80×120×150	42	80×120×175	49
U 7-100/2-120/3	85×110×160	70	85×110×185	80
U 7-180/4-250/5	90×110×150	54	90×110×170	63
U 7-300/6 T	80×120×150	42	80×120×175	49
U 7-300/6 M-350/7 T	80×120×145	35	80×120×170	42
U 9-100/2	85×110×160	70	85×110×185	80
U 9-150/3-200/4	90×110×150	54	90×110×170	63
U 9-250/5	80×120×150	42	80×120×175	49
U 18-180/2-250/3	90×110×150	54	90×110×170	63
U 18-400/4	80×120×145	35	80×120×170	42



# ULTRA

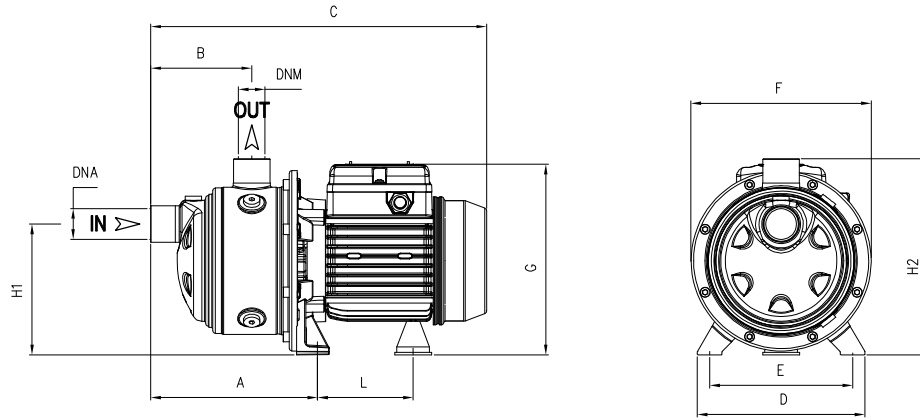

TYPE	DIMENSIONS (mm)											Kg		
	A	B	C	D	E	F	G	L	H1	H2	DNA			DNM
U 3-50/2	166,8	103	333	164	140	178	190	93,7	128	192	1" G	1" G	6,5	T 6
U 3-70/3	166,8	103	333	164	140	178	190	93,7	128	192			7	
U 3-90/4	190,8	127	357	164	140	178	190	93,7	128	192			8,5	
U 3-100/5	214,8	151	404	164	140	178	203	104,7	128	192			10,5	
U 3-120/6	238,8	175	428	164	140	178	203	104,7	128	192			11,5	
U 3-150/7	262,8	199	513	164	140	201	211	128,2	134	198			14,5	T 14
U 5-70/2	166,8	103	333	164	140	178	195	93,7	128	192			7	
U 5-80/3	166,8	103	357	164	140	178	203	93,7	128	192			9,5	T 10,5
U 5-120/4	190,8	127	380	164	140	178	203	104,7	128	192			11	
U 5-150/5	214,8	151	466	164	140	201	211	128,2	134	198			13,5	
U 5-180/6	238,8	175	489	164	140	201	211	128,2	134	198	15	T 14		
U 5-200/7	262,8	199	513	164	140	201	211	128,2	134	198	15,5	T 15		

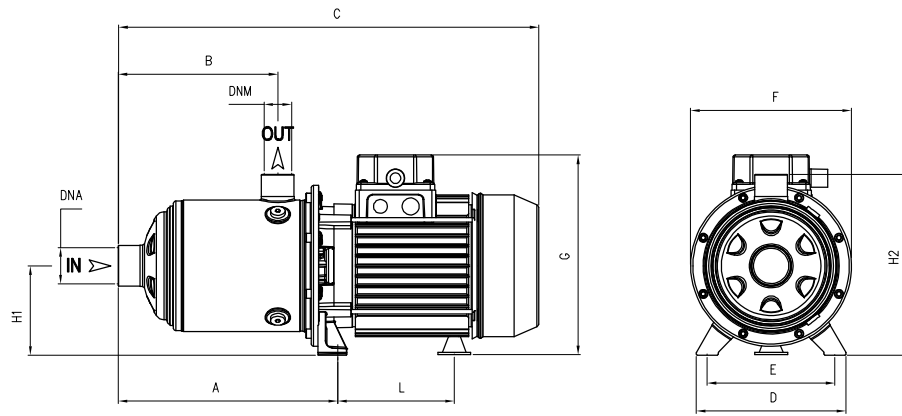

TYPE	DIMENSIONS (mm)											Kg		
	A	B	C	D	E	F	G	L	H1	H2	DNA			DNM
U 7-100/2	166,8	103	356	164	140	178	203	104,7	92	192	1" 1/4 G	1" G	10	
U 7-120/3	166,8	103	356	164	140	178	203	104,7	92	192			10,5	
U 7-180/4	190,8	127	441	164	140	201	211	128,2	98	198			14	T 13
U 7-250/5	214,8	151	466	164	140	201	211	128,2	98	198	16	T 15		
U 7-300/6	238,8	175	543 T 489	164	140	201	229 T 211	148,2 T 128,2	103 T 98	203 T 198	1" 1/2 G	1" 1/4 G	18	T 16
U 7-350/7	262,8	199	567	164	140	201	229	148,2	103	203			21,5	
U 9-100/2	185,8	118	375	164	140	178	203	104,7	98	192			10	
U 9-150/3	185,8	118	405	164	140	201	211	128,2	98	198	13			
U 9-200/4	215,8	148	466	164	140	201	211	128,2	98	198	15	T 14		
U 9-250/5	245,8	178	494	164	140	201	211	128,2	98	198	16	T 15,5		
U 18-180/2 T	201	141	462	164	140	201	211	128,2	98	198	2" G	1" 1/2 G	13	
U 18-250/3 T	238,5	141	462	164	140	201	211	128,2	98	198			15	
U 18-400/4 T	276	178,5	554	164	140	201	229	148,2	103	203			24	

