

50Hz



GENERAL CATALOGUE

Edition 2022

www.pentax-pumps.it

Where there's water there's Pentax



Viale dell'Industria, 1
37040 Veronella (VR) - Italia
Tel. +39 0442 489500
Fax +39 0442 489510
com@pentax-pumps.it
www.pentax-pumps.it

PENTAX s.p.a.



ULTRA S

Multistage Horizontal

Stainless steel multistage horizontal pumps. Pumping of clean non-loaded fluids, pressurizing system, irrigation, drinking and glycol water, water treatment, heating and air conditioning, washing system.

Construction features

Pump body, mechanical seal housing	stainless steel AISI 304
Motor bracket	aluminium
Impeller, diffusers	stainless steel AISI 304
Mechanical seal	ceramic-graphite ≤ 6 impellers graphite-silicon carbide ≥ 7 impellers
Motor shaft	stainless steel AISI 303
Liquid temperature	-15 ÷ +110 °C
Operating pressure	max 8,5 bar

Motor

	3~ 230/400V-50Hz
2 poles induction motor	1~ 230V-50Hz (with thermal protection up to 1,85 kW)
Insulation class	F
Protection degree	IPX4



U 3 S - 120/6 T

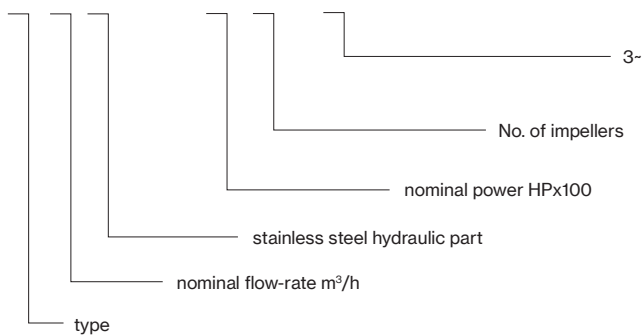

ULTRA 3S



ULTRA 5S



ULTRA 7S



ULTRA 9S



ULTRA 18S



ULTRA S

TYPE		P2		P1 (kW)		AMPERE		Q (m³/h - l/min)						
1-	3-					1-	3-	0	0,6	1,2	1,8	2,4	3,6	4,
						0	10	20	30	40	60	8		
		HP	kW	1-	3-	1x230 V 50 Hz	3x400 V 50 Hz	H (m)						
U 3S-50/2	U 3S-50/2T	0,5	0,37	0,41	0,41	1,8	0,9	21,7	20,9	19,3	17,8	15,9	11,4	5,8
U 3S-70/3	U 3S-70/3 T	0,7	0,51	0,61	0,58	2,7	1,1	32,7	31,2	29,2	26,7	23,9	17,2	9,0
U 3S-90/4	U 3S-90/4 T	0,9	0,66	0,83	0,8	3,6	1,7	44,3	42,8	40,0	36,4	33,2	24,5	13,9
U 3S-100/5	U 3S-100/5 T	1	0,75	0,99	0,92	4,4	1,7	55,3	53,5	50,3	46,5	42,1	31,6	17,7
U 3S-120/6	U 3S-120/6 T	1,2	0,9	1,11	1,11	5,1	2,5	66,6	64,4	60,8	56,0	50,7	38,1	22,4
U 3S-150/7	U 3S-150/7 T	1,5	1,1	1,38	1,31	6,4	2,7	80,1	77,7	74,2	69,1	63,3	48,8	30,0

TYPE		P2		P1 (kW)		AMPERE		Q (m³/h - l/min)							
1-	3-					1-	3-	0	1,8	2,4	3,6	4,8	6	7,2	8,4
						0	30	40	60	80	100	1			
		HP	kW	1-	3-	1x230 V 50 Hz	3x400 V 50 Hz	H (m)							
U 5S-70/2	U 5S-70/2 T	0,7	0,51	0,6	0,58	2,6	1,1	22,3	20,4	19,5	17,5	14,8	11,7	7,8	2,8
U 5S-80/3	U 5S-80/3 T	0,8	0,6	0,8	0,75	3,8	1,4	34,0	31,1	29,9	27,0	23,6	19,1	13,1	6,0
U 5S-120/4	U 5S-120/4 T	1,2	0,9	1,09	1,08	4,9	2,4	45,5	42,2	40,7	37,2	32,9	27,4	19,8	10,4
U 5S-150/5	U 5S-150/5 T	1,5	1,1	1,39	1,31	6,5	2,7	57,2	53,4	51,7	47,6	42,3	35,2	25,7	14,0
U 5S-180/6	U 5S-180/6 T	1,8	1,3	1,63	1,55	7,3	3	68,9	64,4	62,3	57,5	51,5	43,5	32,6	18,1
U 5S-200/7	U 5S-200/7 T	2	1,5	1,94	1,77	8,7	3,3	81,0	75,5	73,0	67,4	60,3	51,0	38,6	21,0

TYPE		P2		P1 (kW)		AMPERE		Q (m³/h - l/min)									
1-	3-					1-	3-	0	2,4	3,6	4,8	6	7,2	8,4	9,6	1	
						0	40	60	80	100	120	140	160	1			
		HP	kW	1-	3-	1x230 V 50 Hz	3x400 V 50 Hz	H (m)									
U 7S-100/2	U 7S100/2 T	1	0,75	0,91	0,84	4,1	1,6	23,6	22,6	21,8	20,5	18,8	16,7	13,9	10,6	6,7	
U 7S-120/3	U 7S-120/3 T	1,2	0,9	1,23	1,22	5,6	2,5	35,6	33,9	32,8	31,2	28,1	24,7	20,8	15,7	10,0	
U 7S-180/4	U 7S-180/4 T	1,8	1,3	1,69	1,62	7,7	3,1	48,0	46,3	45,7	43,6	40,4	36,4	31,4	25,0	17,2	
U 7S-250/5	U 7S-250/5 T	2,5	1,85	2,19	2,05	10,2	4,1	60,3	59,0	58,2	55,7	52,2	47,4	41,3	33,5	22,0	
U 7S-300/6	U 7S-300/6 T	3	2,2	2,53	2,44	11,4	4,	72,5	70,5	69,2	66,0	61,5	55,7	47,8	37,8	24,7	
-	U 7S-350/7 T	3,5	2,57		2,84		5,1	83,5	80,7	78,8	74,7	69,4	62,6	53,9	42,7	27,5	

TYPE		P2		P1 (kW)		AMPERE		Q (m³/h - l/min)											
1-	3-					1-	3-	0	3,6	4,8	6	7,2	8,4	9,6	10,8	12	13,2	14,4	
						0	60	80	100	120	140	160	180	200					
		HP	kW	1-	3-	1x230 V 50 Hz	3x400 V 50 Hz	H (m)											
U 9S-100/2	U 9S-100/2 T	1	0,75	0,99	0,95	4,5	1,6	23,9	20,9	20,0	18,8	17,7	16,5	15,0	13,0	11,0	8,7	6,0	
U 9S-150/3	U 9S-150/3 T	1,5	1,1	1,47	1,4	6,8	2,8	35,6	32,5	31,5	30,0	28,7	26,9	24,6	22,0	18,7	15,0	10,7	
U 9S-200/4	U 9S-200/4 T	2	1,5	1,88	1,77	8,4	3,3	47,6	43,5	42,1	40,1	38,1	35,7	32,7	28,9	24,2	19,0	13,1	
U 9S-250/5	U 9S-250/5 T	2,5	1,85	2,36	2,23	10,8	4,3	60,0	54,8	53,0	51,0	48,2	45,4	42,0	37,3	31,6	25,0	18,0	

TYPE		P2		P1 (kW)	A	Q (m³/h - l/min)																	
3-	3-					0	6	7,2	8,4	9,6	10,8	12	13,2	14,4	15,6	16,8	18	19,2	20,4	21,6	22,8	24	25,
						0	100	120	140	160	180	200	220	240	260	280	300	320	340	360	380	400	420
		HP	kW	3-	3x400 V 50 Hz	H (m)																	
U 18S-180/2 T		1,8	1,3	1,59	3	23,7	21,7	21,1	20,4	20,0	19,3	18,5	17,7	16,9	16,0	15,2	14,3	13,1	11,8	10,3	9,1	7,6	6,4
U 18S-250/3 T		2,5	1,85	2,29	4,4	35,7	33,1	32,3	31,3	30,4	29,4	28,4	27,4	26,3	25,1	24,0	22,8	21,4	19,6	17,8	15,4	12,9	10,2
U 18S-400/4 T		4	3	3,1	5,7	47,9	45,0	44,0	42,8	41,7	40,5	39,1	37,8	36,6	35,2	33,9	32,2	30,2	28,0	25,1	22,1	18,1	14,9



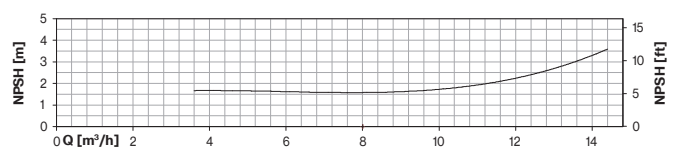
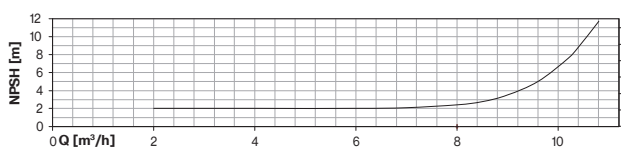
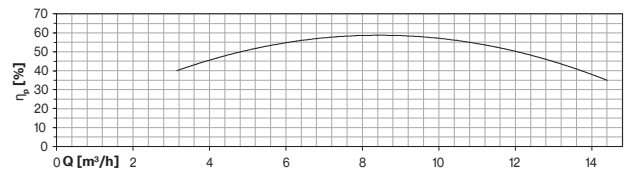
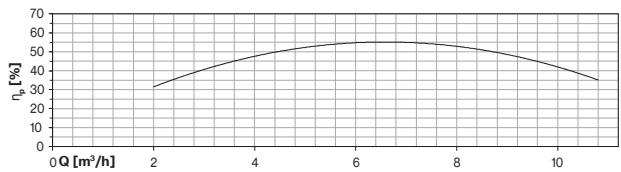
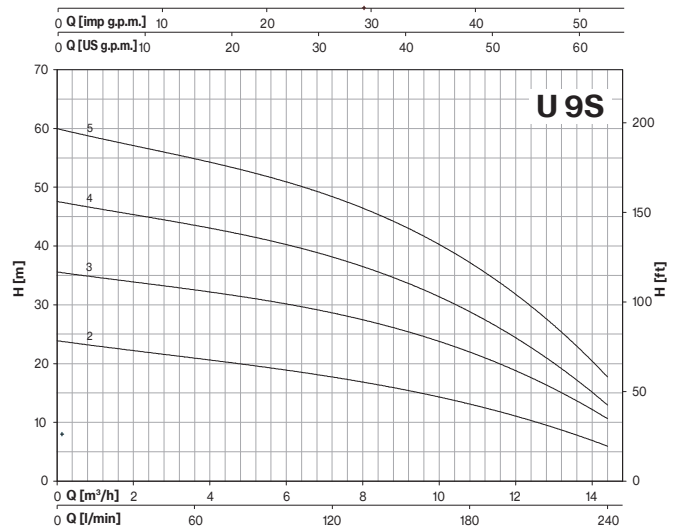
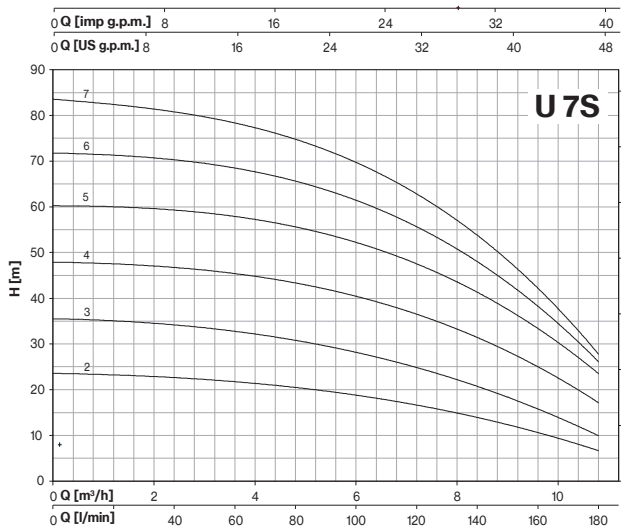
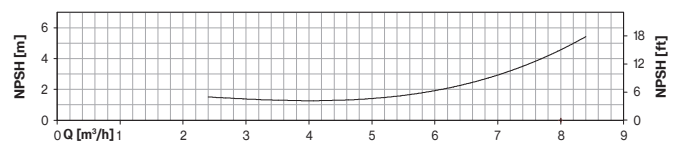
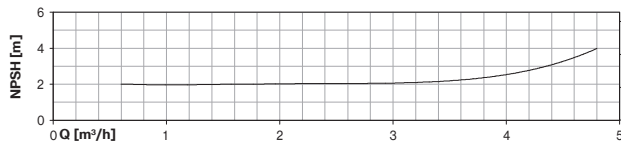
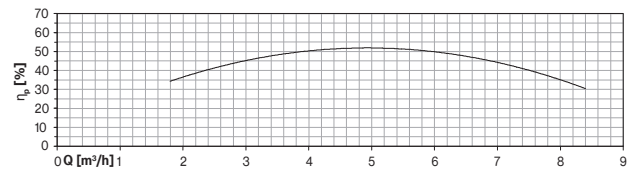
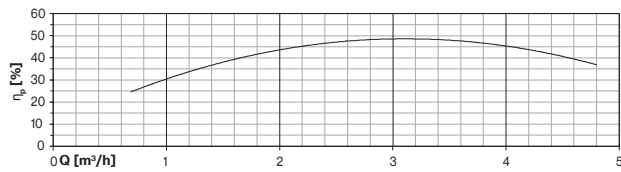
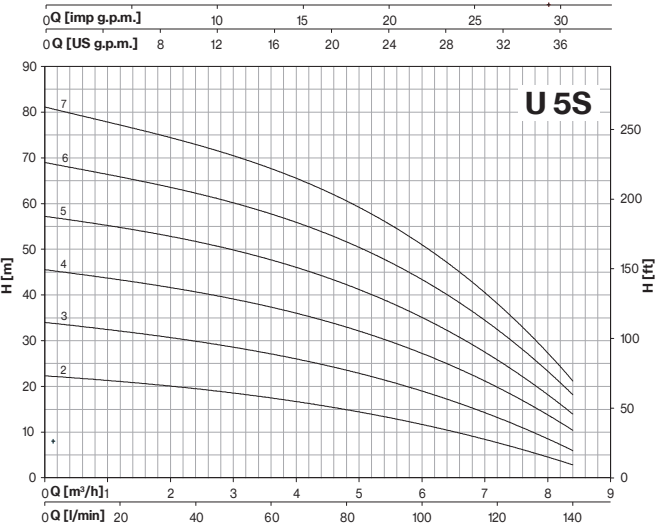
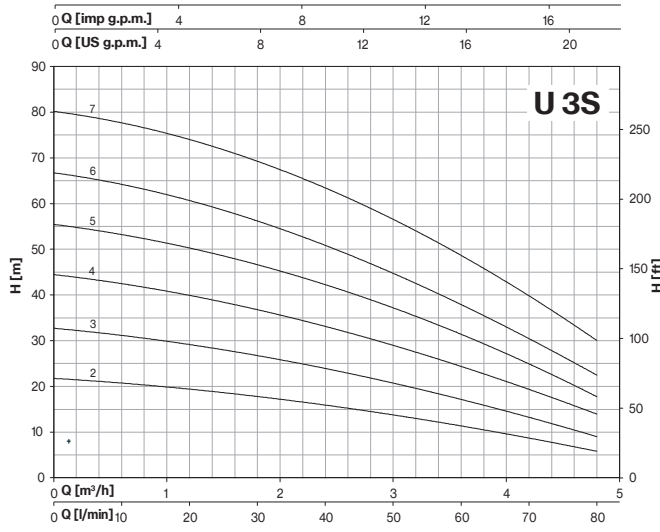

ULTRA S

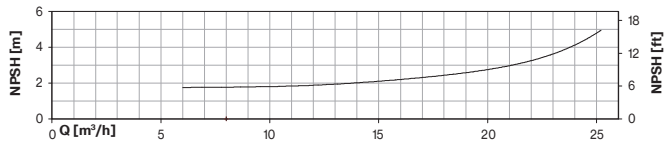
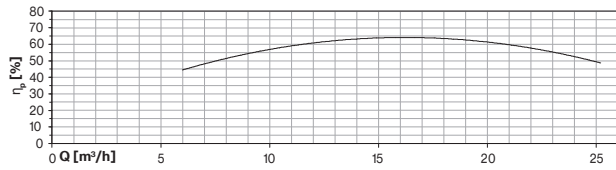
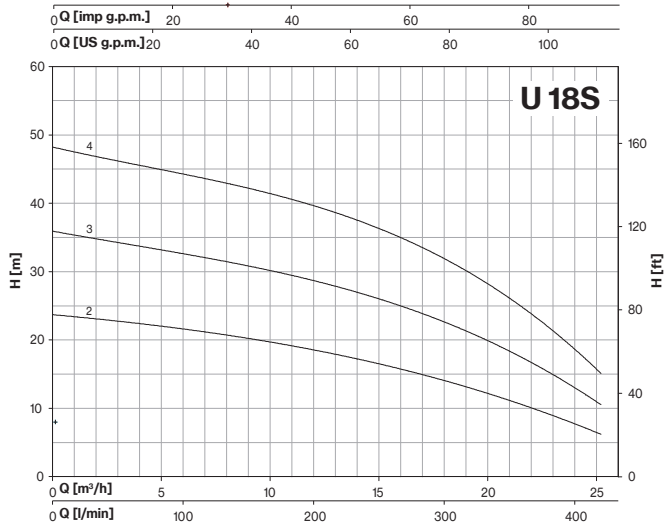

TYPE	LOTS			
	TRUCK		CONTAINER	
	PALLET (cm)	N° pumps	PALLET (cm)	N° pumps
U 3S-50/2-90/4	80×120×150	84	80×120×175	96
U 3S-100/5-120/6	85×110×160	70	85×110×185	80
U 3S-150/7	80×120×150	42	80×120×175	49
U 5S-70/2	80×120×150	84	80×120×175	96
U 5S-80/3-120/4	85×110×160	70	85×110×185	80
U 5S-150/5	90×110×150	54	90×110×170	63
U 5S-180/6-200/7	80×120×150	42	80×120×175	49
U 7S-100/2-120/3	85×110×160	70	85×110×185	80
U 7S-180/4-250/5	90×110×150	54	90×110×170	63
U 7S-300/6 T	80×120×150	42	80×120×175	49
U 7S-300/6 -350/7 T	80×120×145	35	80×120×170	42
U 9S-100/2	85×110×160	70	85×110×185	80
U 9S-150/3-200/4	90×110×150	54	90×110×170	63
U 9S-250/5	80×120×150	42	80×120×175	49
U 18S-180/2-250/3	90×110×150	54	90×110×170	63
U 18S-400/4	80×120×145	35	80×120×170	42



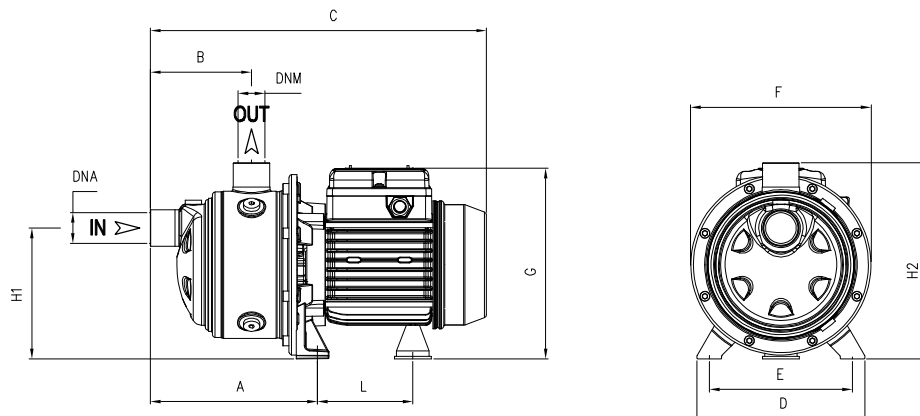

TYPE	DIMENSIONS (mm)												Kg	
	A	B	C	D	E	F	G	L	H1	H2	DNA	DNM		
U 3S-50/2	166,8	103	333	164	140	178	190	93,7	128	192	1" G	1" G	7	
U 3S-70/3	166,8	103	333	164	140	178	190	93,7	128	192			8	
U 3S-90/4	190,8	127	357	164	140	178	190	93,7	128	192			9,5	
U 3S-100/5	214,8	151	404	164	140	178	203	104,7	128	192			12	
U 3S-120/6	238,8	175	428	164	140	178	203	104,7	128	192			13	
U 3S-150/7	262,8	199	513	164	140	201	211	128,2	134	198			16	
U 5S-70/2	166,8	103	333	164	140	178	195	93,7	128	192			7,5	
U 5S-80/3	166,8	103	357	164	140	178	203	93,7	128	192			10	
U 5S-120/4	190,8	127	380	164	140	178	203	104,7	128	192			12	
U 5S-150/5	214,8	151	466	164	140	201	211	128,2	134	198			15	T 14,5
U 5S-180/6	238,8	175	489	164	140	201	211	128,2	134	198	16,5	T 15,5		
U 5S-200/7	262,8	199	513	164	140	201	211	128,2	134	198	17,5	T 17		

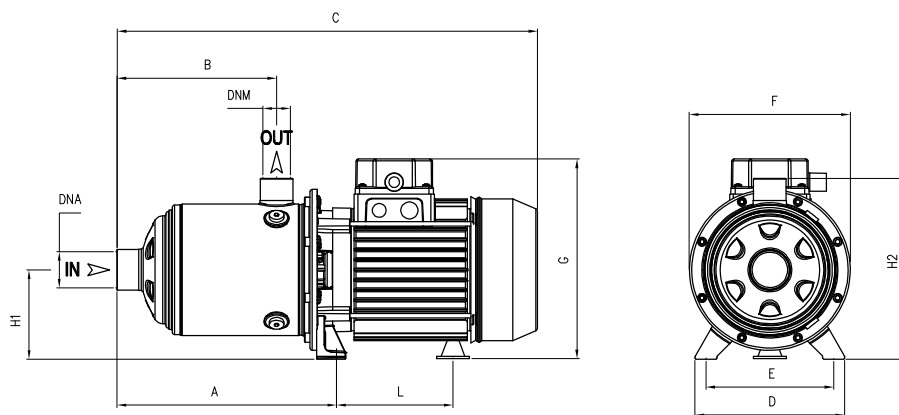

TYPE	DIMENSIONS (mm)												Kg	
	A	B	C	D	E	F	G	L	H1	H2	DNA	DNM		
U 7S-100/2	166,8	103	356	164	140	178	203	104,7	103	192	1" 1/4 G	1" G	10,5	
U 7S-120/3	166,8	103	356	164	140	178	203	104,7	92	192			11,5	
U 7S-180/4	190,8	127	441	164	140	201	211	128,2	98	198			15	T 14
U 7S-250/5	214,8	151	466	164	140	201	211	128,2	98	198			17,5	T 16,5
U 7S-300/6	238,8	175	543	164	140	201	229	148,2	103	203			19,5	T 18
U 7S-350/7	262,8	199	567	164	140	201	229	148,2	92	203			23	
U 9S-100/2	185,8	118	375	164	140	178	203	104,7	98	192	1" 1/2 G	1" 1/4 G	10,5	
U 9S-150/3	185,8	118	405	164	140	201	211	128,2	98	198			14	
U 9S-200/4	215,8	148	466	164	140	201	211	128,2	98	198			16	T 15,5
U 9S-250/5	245,8	178	494	164	140	201	211	128,2	98	198			18	T 17
U 18S-180/2 T	201	141	462	164	140	201	211	128,2	98	198	2" G	1" 1/2 G	14	
U 18S-250/3 T	238,5	141	462	164	140	201	211	128,2	98	198			16	
U 18S-400/4 T	276	178,5	554	164	140	201	229	148,2	103	203			25,5	

