

50Hz



GENERAL CATALOGUE

Edition 2022

www.pentax-pumps.it

Where there's water there's Pentax



Viale dell'Industria, 1
37040 Veronella (VR) - Italia
Tel. +39 0442 489500
Fax +39 0442 489510
com@pentax-pumps.it
www.pentax-pumps.it

PENTAX s.p.a.



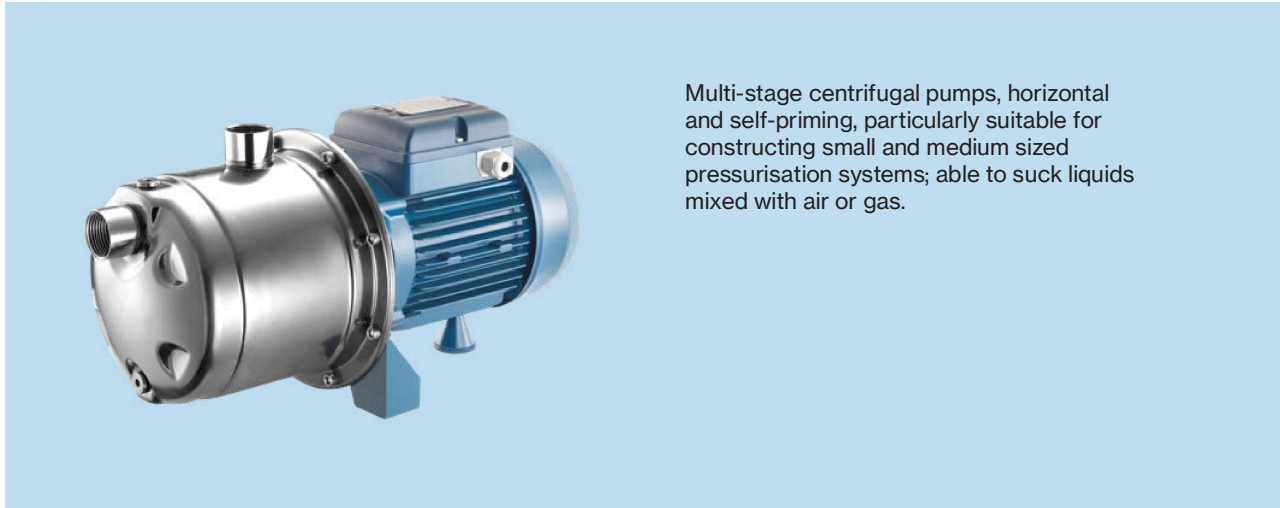

Multi-stage centrifugal pumps, horizontal and self-priming, particularly suitable for constructing small and medium sized pressurisation systems; able to suck liquids mixed with air or gas.

Construction features

Pump body	stainless steel AISI 304
Motor bracket	aluminium
Impeller	Noryl®
Mechanical seal	ceramic-graphite
Pump shaft	stainless steel AISI 416
Liquid temperature	0 - 50 °C
Operating pressure	max 8 bar

Motor

	3~ 230/400V-50Hz
2 poles induction motor	1~ 230V-50Hz (with thermal protection)
Insulation class	F
Protection degree	IPX4

TYPE	LOTS			
	TRUCK		CONTAINER	
	PALLET (cm)	N° pumps	PALLET (cm)	N° pumps
MPX	85×110×170	60	85×110×190	80



MPX

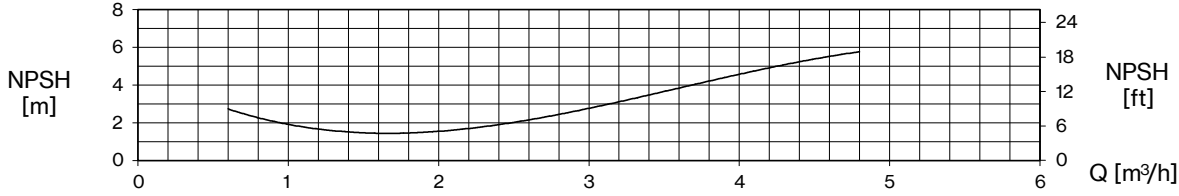
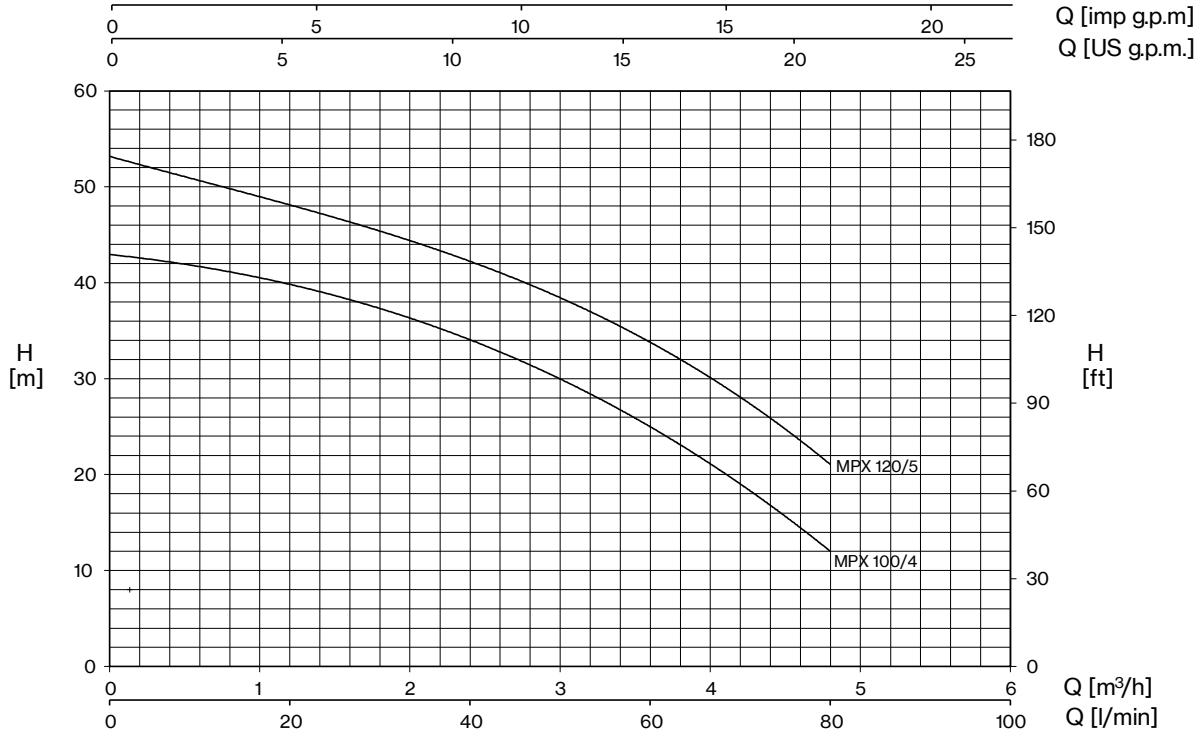

TYPE		P2		P1 (kW)		AMPERE		Q (m³/h - l/min)					
1~	3~	HP	kW	1~	3~	1~ 1x230 V 50 Hz	3~ 3x400 V 50 Hz	0	0,6	1,2	2,4	3,6	4,8
								0	10	20	40	60	8
								H (m)					
MPX 100/4	MPXT 100/4	1	0,74	1,07	1,1	5	1,9	43	41,5	40	34	25	1
MPX 120/5	MPXT 120/5	1,2	0,88	1,27	1,33	6,1	2,3	53	51	48	42	34	21

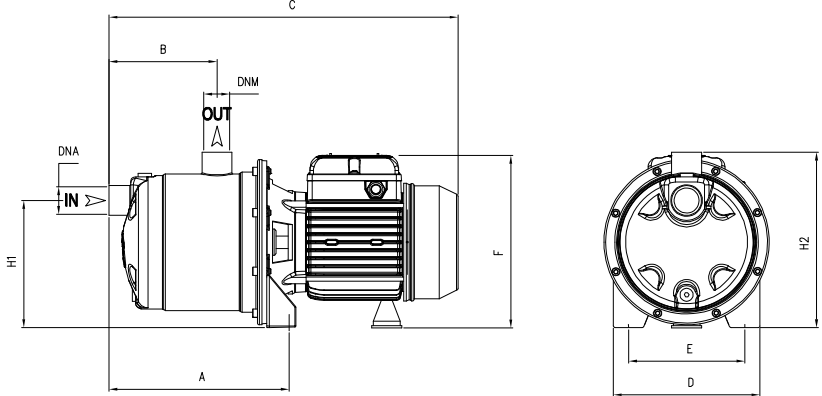

TYPE	DIMENSIONS (mm)													
	A	B	C	D	E	F	H1	H2	DNA	DNM	I	L		M
MPX 100/4	208	128	410	175	140	215	153	210			430	210	235	11
MPX 120/5	208	128	410	175	140	215	153	210	1" G	1" G	430	210	235	11,5



MPX (Garden version)

Portable electropumps complete with cable and plug, switch. The performances depend on adopted pump type.



MPX



MPX BOX

TYPE	P2		P1 (kW)	Pipe		Performance	
	HP	kW		Suction ("G)	Delivery ("G)	Q (l/min)	H (m)
MPX 100/4	1	0,74	1,07	1	1	10-80	41,5-12
MPX 120/5	1,2	0,88	1,27	1	1	10-80	51-21

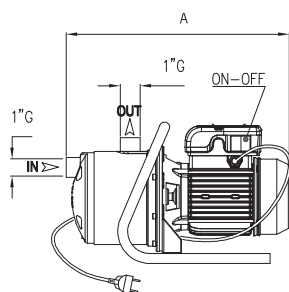

INOX / MPX

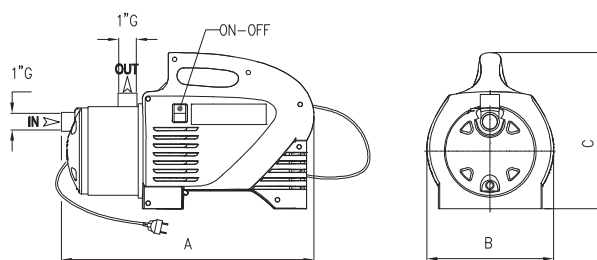
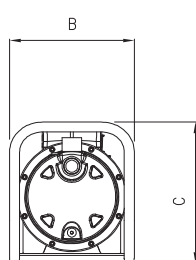

INOX / MPX

TYPE	DIMENSIONS (mm)		
	A	B	C
MPX 100/4	410	175	285
MPX 120/5	410	175	285
MPX 100/4 BOX	429	209	287

